

## Series LS14K

### **Hydraulic Cable Winches**

*"Quality Since  
1910"*

Lift-Safe® hydraulic winches are specifically designed for lifting applications and optimum load control. Engineered for enhanced safety with redundant braking systems, and available in a variety of configurations. Lift-Safe® winches utilize the **DUET-SAFE® Double Action Braking System** to provide both static and dynamic braking. Lift-Safe® winches offer increased operational flexibility, and superior load control in lifting applications. LS14K Series direct drive winches are used for industrial pulling and hoisting applications, fishing boats, marine craft, drill rigs, small cranes, factory material handling and rear load waste handlers.



**Up To 15,000 LBS.  
CAPACITY**

## Lift-Safe® Hydraulic Cable Winches – Standard Features

- |                   |  |
|-------------------|--|
| <b>BRAKE</b>      | - <b>DUET-SAFE® Double Action Braking System</b> combines a powerful spring applied, hydraulic released brake with a double counter balance brake valve to automatically hold loads when hydraulic pressure is released and control speed during lowering operations. Winch is ideal for high speed lifting and pulling applications or wherever load holding is critical. |
| <b>GEAR CASE</b>  | - Made of high strength cast iron. Completely sealed for oil enclosed operation and to keep dirt out.  |
| <b>WORM SHAFT</b> | - One piece alloy steel hardened and ground for extra durability. Seal on worm allows brake to be removed without draining oil.  |
| <b>WORM GEAR</b>  | - High tensile aluminum-nickel alloy bronze cast on high strength ductile iron hub. Optimum lead and pressure angles transmit maximum power to the drum.   |
| <b>GEAR RATIO</b> | - 25:1 standard & 12.5:1 optional ratios provide optimum efficiency in power and speed.  |
| <b>BEARINGS</b>   | - Worm gear and worm shaft run on tapered roller bearings. Outer end housing has a grease zerk for lubricating the bronze bushing.   |
| <b>DRUM SHAFT</b> | - 2-1/4" diameter heat-treated alloy steel minimum tensile strength 150,000 psi.   |
| <b>CABLE DRUM</b> | - Tough all steel construction resists breakage or warping.  |



# BLOOM

Manufacturing Inc.

Winch Division

*Lifting  
Pulling  
Hoisting*

Toll Free Number: 1-800-394-1139

www.bloommfg.com

**"Custom Engineered Solutions"**

1443 220<sup>th</sup> Street, Independence, Iowa 50644 • FAX: 319-827-1140 • PHONE: 319-827-1139

**MODEL EXAMPLE: LS14K-6.2M-L14-RH-25-LP**

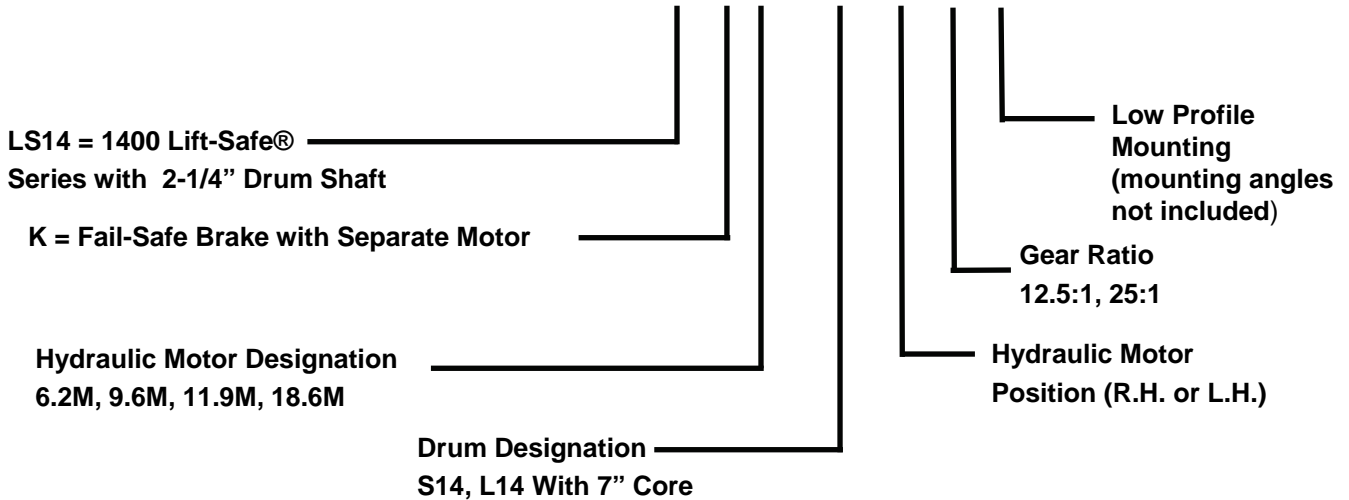

(14K) Indicates a 1400K Series winch with 2 1/4" drum shaft. The "K" indicates spring applied hydraulic released fail-safe brake.

(6.2M) Designates hydraulic motor. Motor size is determined from motor performance charts. All motors come complete with attached double counter balanced valve.

(L14) Drum designation.

## DRUM CAPACITY

CABLE DIAMETER (IN.)	5/16	3/8	7/16	1/2	9/16	5/8
DRUM "S14" CAPACITY (FT.)	615	400	300	225	160	115
DRUM "L14" CAPACITY (FT.)	1100	712	517	409	295	200

(RH) Hydraulic motor may be placed on either side of the gear case. Specify right hand (RH) or left hand (LH) as viewed looking at gear case cover. Right hand is standard.

(25) Indicates gear ratio. 25:1 is standard. ( 12.5:1 Optional )

(LP) Designates low profile mounting. It is necessary on all low profile whether the winch is to be supplied "with angles" or "less angles".

## 1400K Series Model Selection from Performance Data

12.5:1 RATIO (optional)

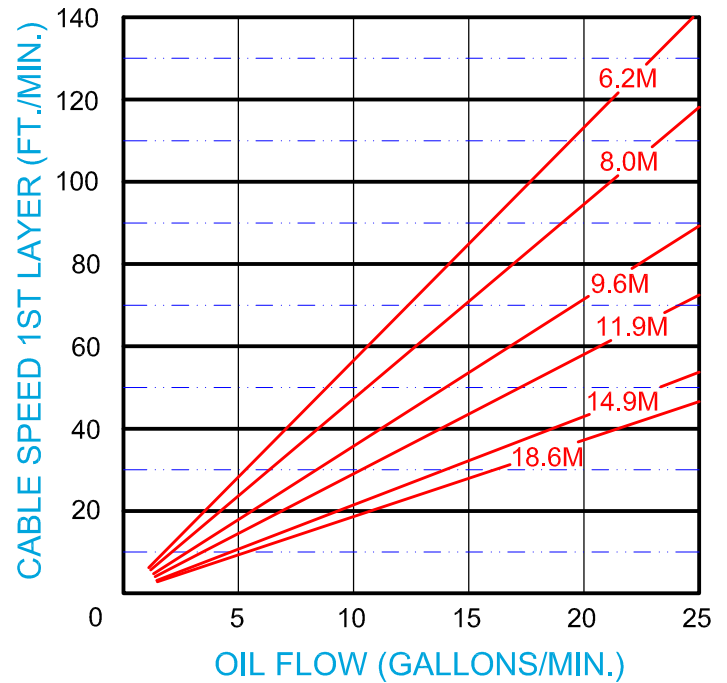
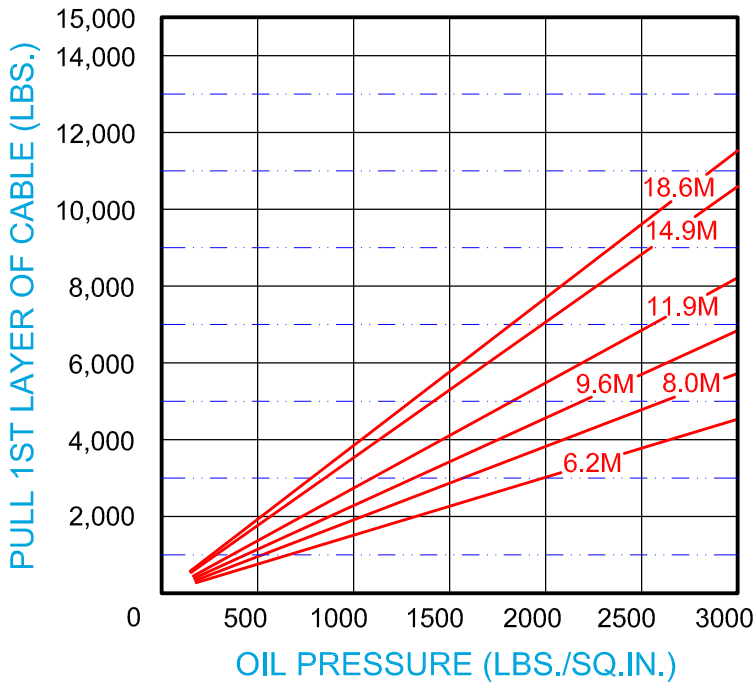

25:1 RATIO (standard)

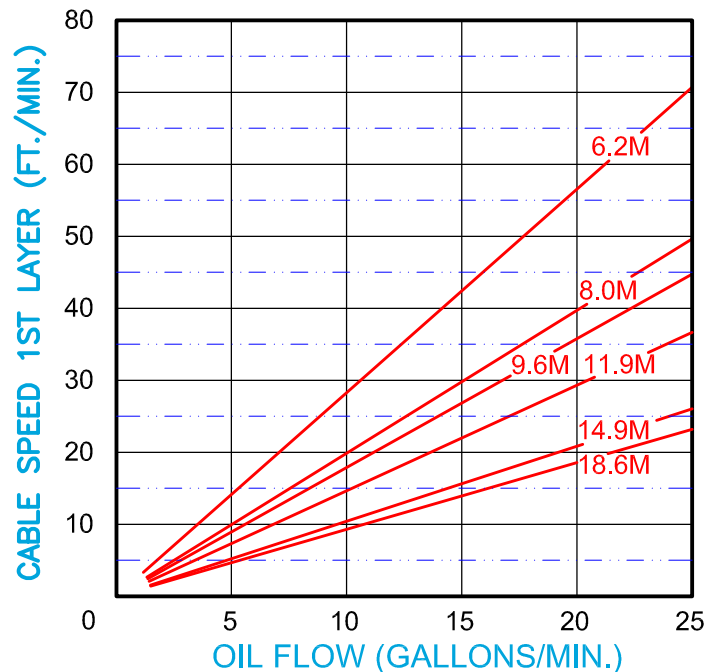
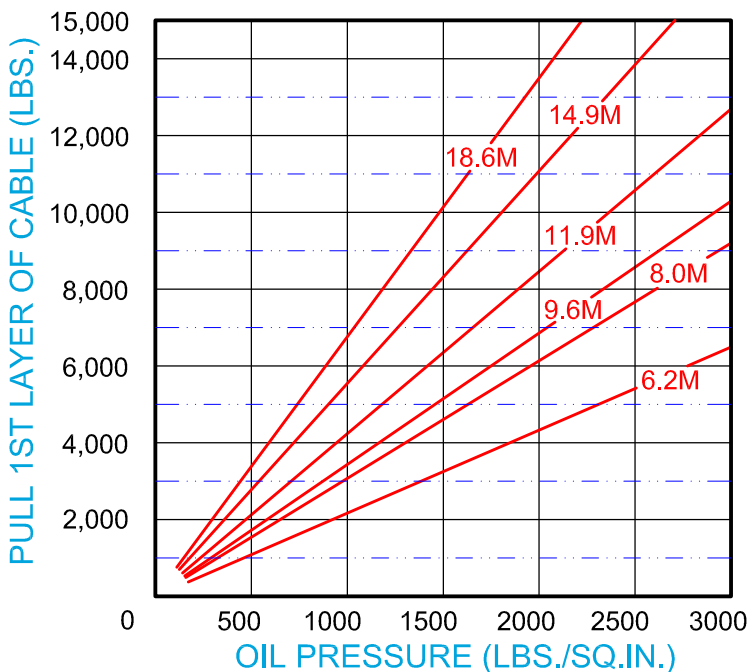

## Bloom Manufacturing Inc.

## Dimensional Drawings

1400K Series With S14 & L14 Drum  
Base Mount Model - Direct Drive

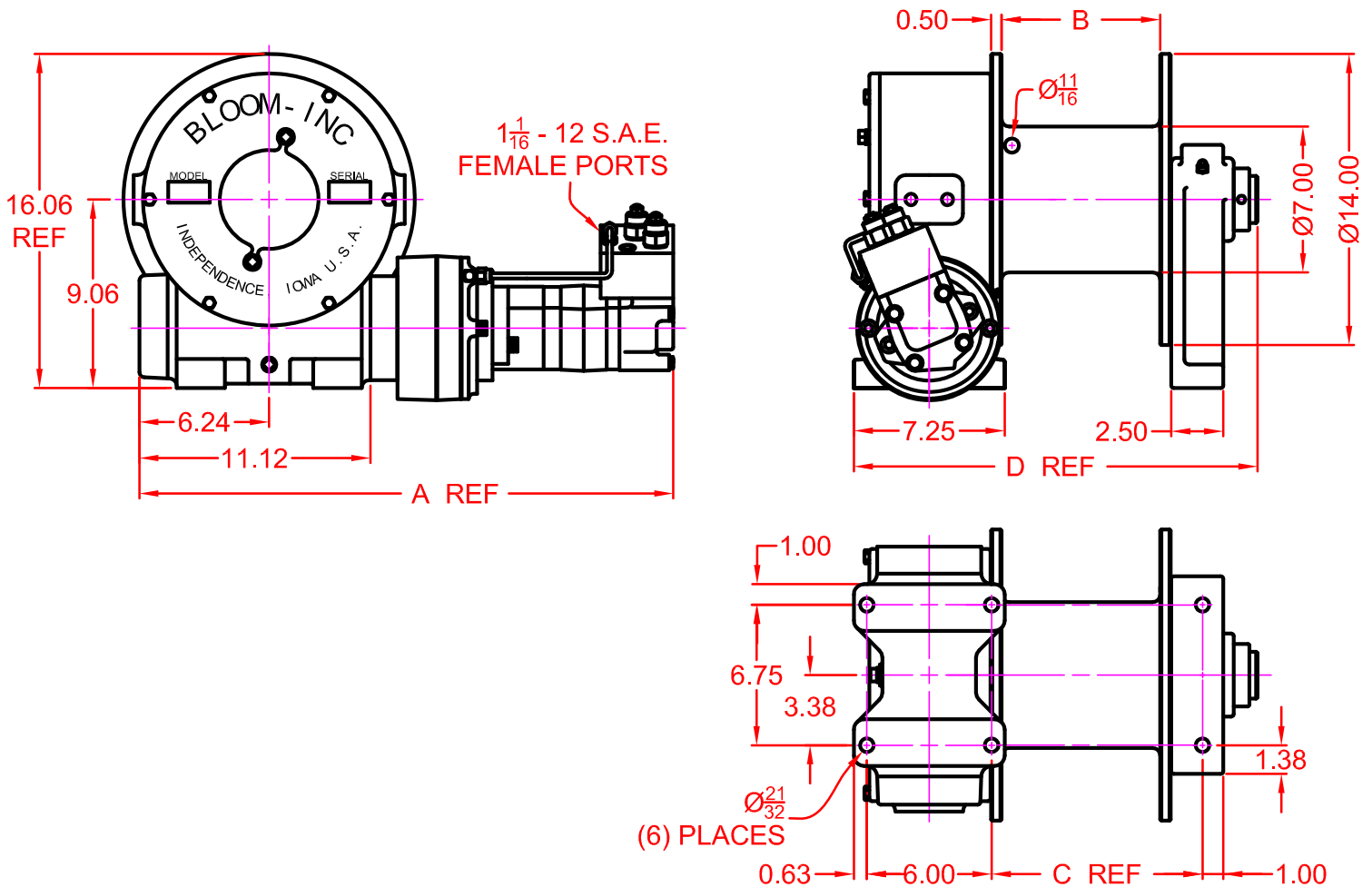

MOTOR DESIGNATION	6.2M	8.0M	9.6M	11.9M	18.6M
A DIMENSION	24.42	24.67	24.67	24.94	25.74

WINCH DESIGNATION	S14		L14		
B DIMENSION	7.63		13.63		
C DIMENSION	10.14		16.14		
D DIMENSION	19.40		25.40		

## Bloom Manufacturing Inc.



Correct choice of Directional Control Valves for Lift-Safe® Winches

All **Lift-Safe®** Winches require a **Motor Spool Control Valve**.

That is the valve's work ports are **open** to tank in neutral position.

\*Winches require ridged mounting plate.  
See owner's manual for information about proper mounting plate thickness or call Bloom Sales Engineer at factory

**WARNING!**

Goods are not intended for use in the moving or lifting of persons!

The winches described herein are neither designed nor intended for use or application to equipment used in the lifting or moving of persons and it is understood that all such use shall be at the sole risk of the user.

The cable clamps on winches are not designed to hold rated loads. A minimum of 5 wraps of cable must be left on drum barrel to guarantee holding of rated load.

Applications of winch where life would be endangered by any event are not recommended.

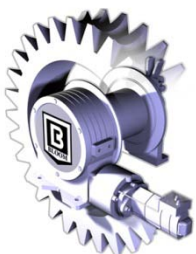

**BLOOM Manufacturing Inc.**  
**Winch Division**

1443 220<sup>th</sup> Street,, Independence, Iowa 50644

FAX 319-827-1140 PHONE 319-827-1139